

SMA PACKAGE
(-S)

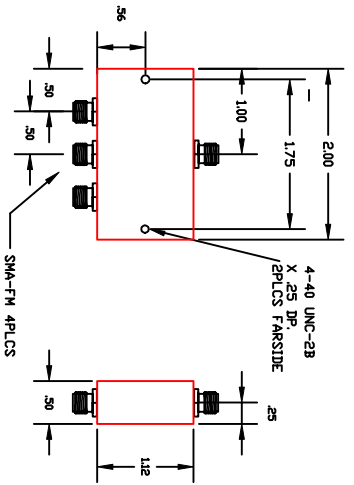

BNC PACKAGE
(-B)

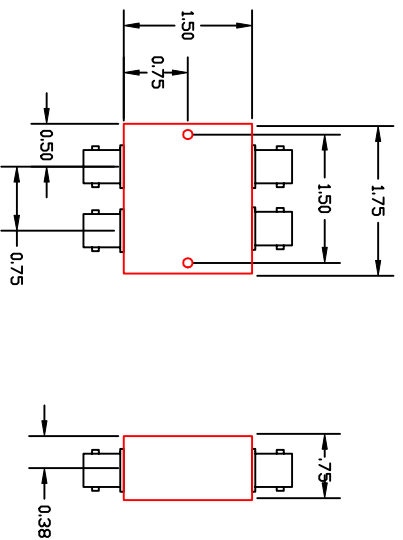

TYPE 'N' PACKAGE
(-N)

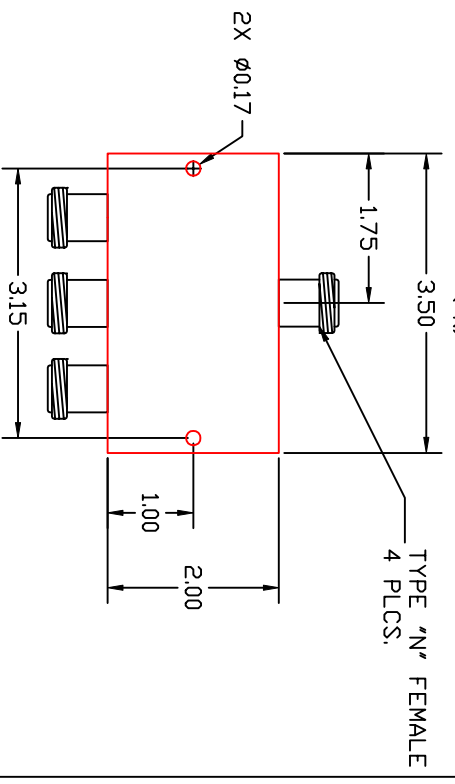

FP FLATPACK
(-FP)

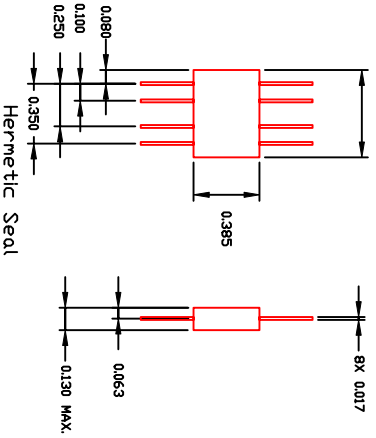

SMT PACKAGE
(-SM1)

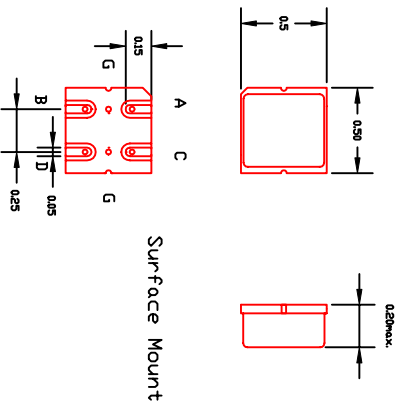

Surface Mount

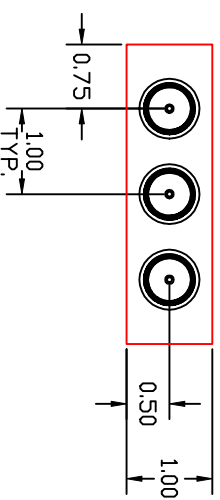

NOTES:

1. SPECIFICATIONS SUBJECT TO CHANGE WITHOUT NOTICE.
2. CONTACT FACTORY FOR OTHER OPTIONS

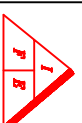

I.F. ENGINEERING

151 CENTER ROAD, DUDLEY MA 01571

Telephone 508-943-5636

Facsimile 508-943-4872

ifeng@ma.ultranet.com

www.ifengineering.com

CODE IDENT NO.

OUF A1